

PNP Transistor



Features

- Epoxy meets UL-94 V-0 flammability rating
- Halogen free available upon request by adding suffix "HF"
- Moisture Sensitivity Level 1
- High Conductance
- Surface mount package ideally Suited for Automatic Insertion

Mechanical Data

- Package:** SOT-23
- Molding compound meets UL 94 V-0 flammability rating, RoHS-compliant, halogen-free
- Terminals:** Tin plated leads, solderable per J-STD-002 and JESD22-B102
- Marking:** 9B

Maximum Ratings (Ta=25 unless otherwise noted)

Item	Symbol	Unit	Value
Collector-Base Voltage	V_{CBO}	V	-40
Collector-Emitter Voltage	V_{CEO}	V	-40
Emitter-Base Voltage	V_{EBO}	V	-5
Collector Current	I_c	A	-1
Collector Power Dissipation	P_c	mW	300
Junction Temperature	T_j		150
Storage Temperature	T_{stg}		-55 to +150



PMMT591A

Electrical Characteristics (Ta=25 unless otherwise noted)

	Symbol	Unit	F DI	T	gh 1 nf
--	--------	------	------	---	---------



PMMT591A

Characteristics (Typical)

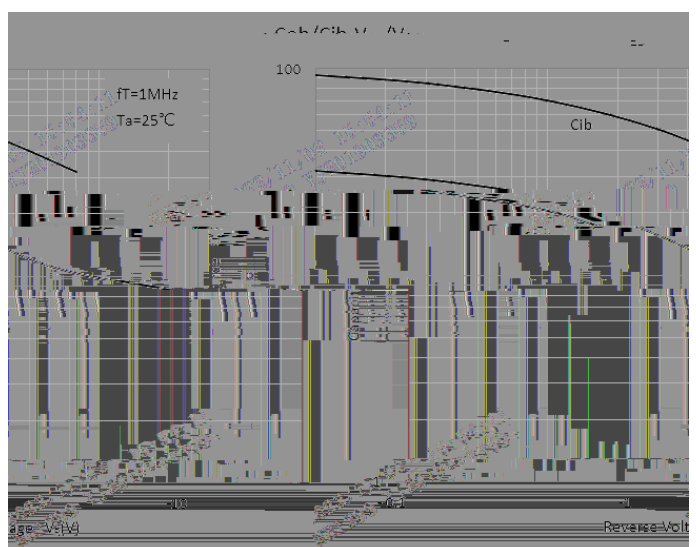
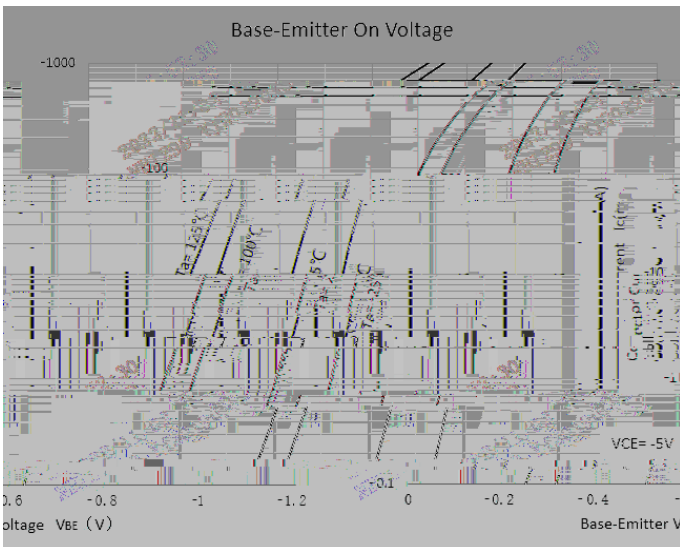
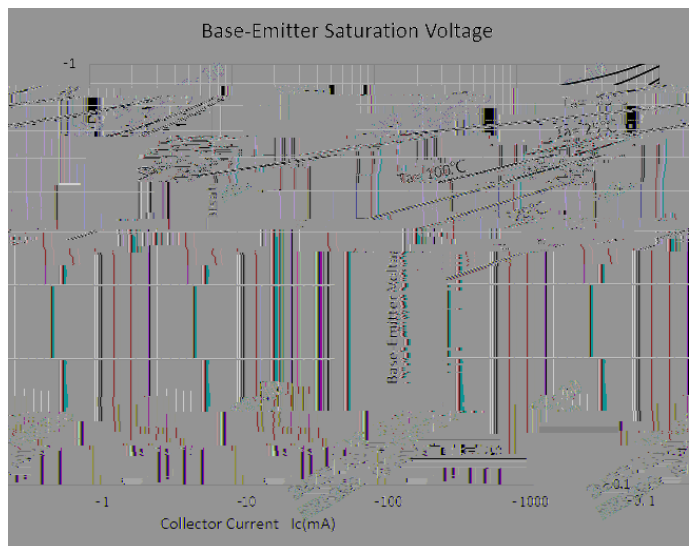
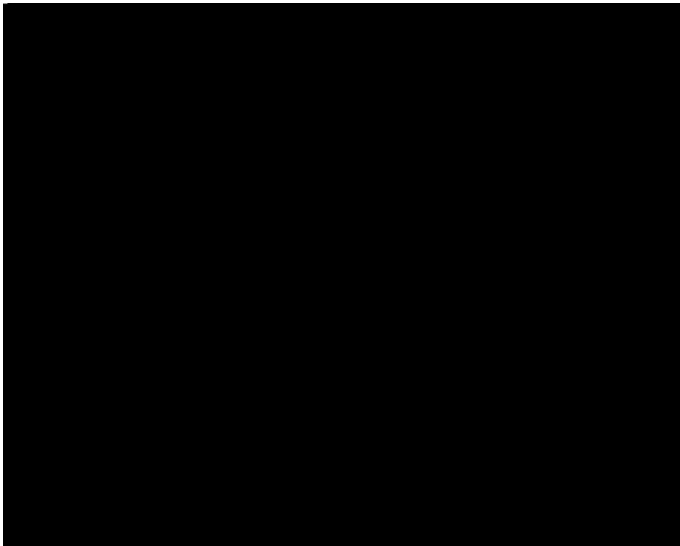
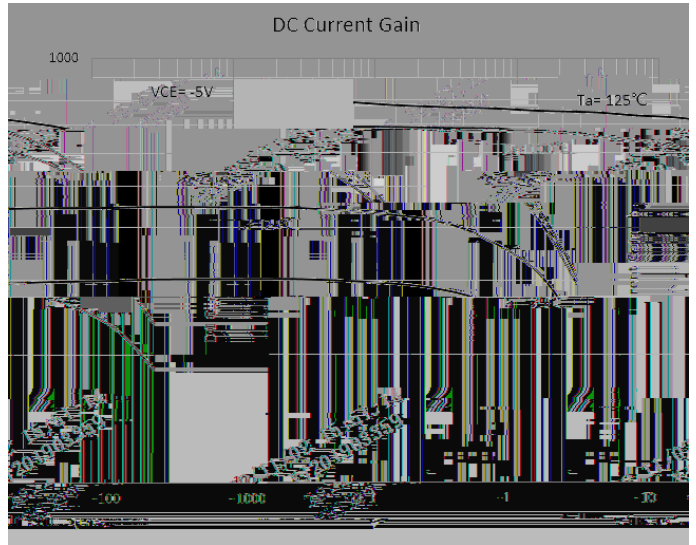
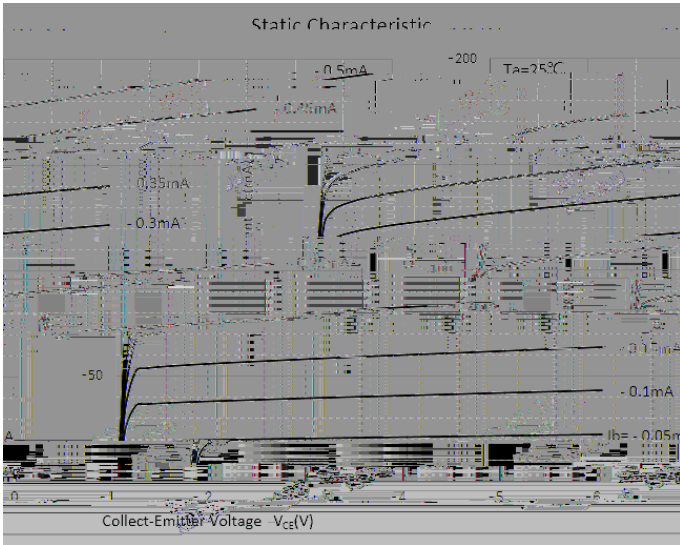



PMMT591A

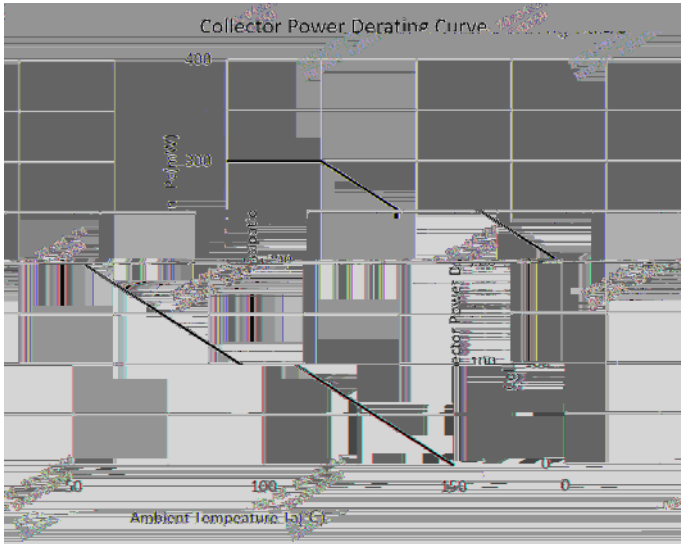

SOT-23 Package Outline Dimensions

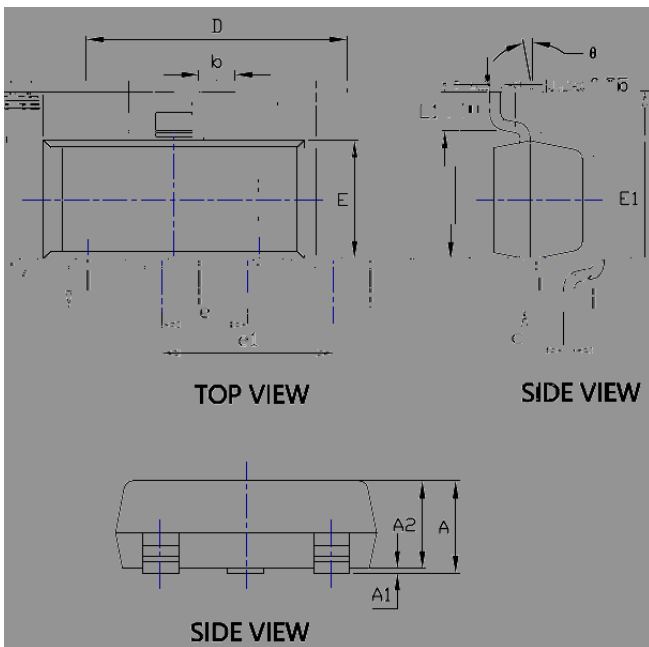

SYMBOL	DIMENSIONS	
	INCHES	Millimeter
D	0.126	3.20
b	0.075	1.90
E	0.050	1.27
e1	0.071	1.80
A1	0.028	0.71
A2	0.025	0.63
θ	8°	8°

SOT-23 Soldering Footprint

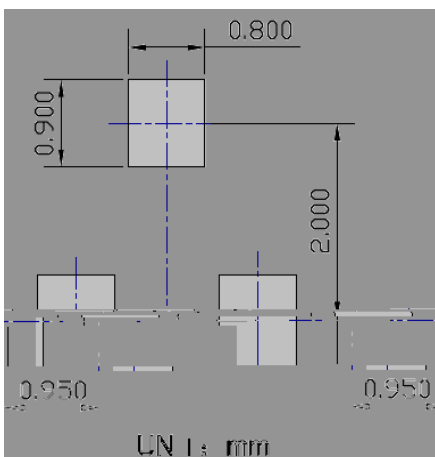



PMMT591A

Disclaimer

The information presented in this document is for reference only. Yangzhou Yangjie Electronic Technology Co., Ltd. reserves the right to make changes without notice for the specification of the products displayed herein to improve reliability, function or design or otherwise.

The product listed herein is designed to be used with ordinary electronic equipment or devices, and not designed to be used with equipment or devices which require high level of reliability and the malfunction of which would directly endanger human life (such as medical instruments, transportation equipment, aerospace machinery, nuclear-reactor controllers, fuel controllers and other safety devices), Yangjie or anyone on its behalf, assumes no responsibility or liability for any damages resulting from such improper use of sale.

This publication supersedes & replaces all information previously supplied. For additional information, please visit our website [http:// www.21yangjie.com](http://www.21yangjie.com) , or consult your nearest Yangjie's sales office for further assistance.